

AVANTE[®]

garage doors

ALUMINUM AND GLASS CONSTRUCTION



America's Favorite Garage Doors[®]



*Avante[®] / Model AX, Bronze (Anodized) Frame with Frosted Tempered Glass
Photo Credit: Andy Frame Photography*

AVANTE®

The perfect choice to modernize any home, our Avante® garage doors turn an ordinary garage into a stunning architectural focal point. Fitted with tempered glass panels, the door fills the garage with natural light during the day and delivers a dramatic effect when the lights come on at night. The commercial-grade aluminum frame can be insulated and comes in a number of colors to complement your home, while a variety of window options let you bring in as much or as little daylight needed without compromising privacy.

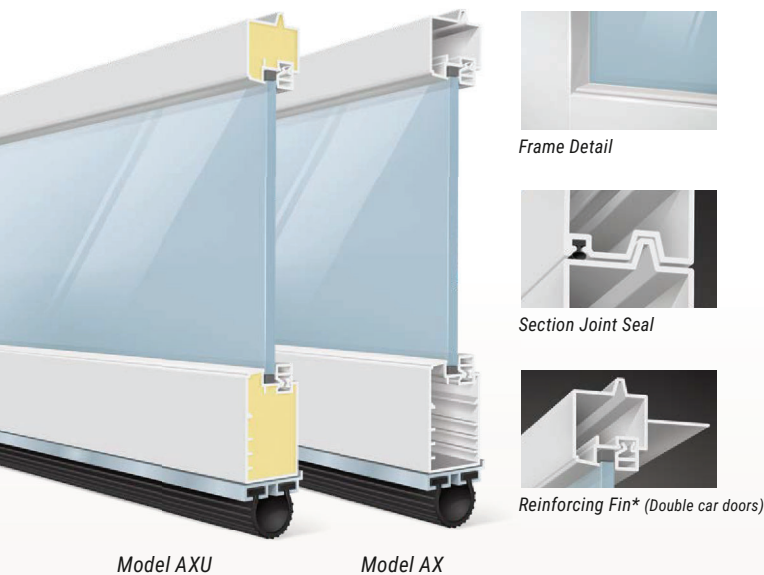

Model AXU

Model AX

STYLE AND CONSTRUCTION

- Aluminum frame provides a virtually maintenance-free, long-lasting door.
- Intellicore® polyurethane insulated rails and stiles. (Model AXU)
- R-value 3.8/U-factor 0.86. (Model AXU when glazed with clear insulated glass)
- Many glass and panel options available.
- Section joint seal helps keep out air and water.
- Integral reinforcing fin provides increased strength and longevity. (Available on double car models)
- Heavy-duty steel ball bearing rollers with nylon tires provide quiet operation.

*Doors wider than 14' include built-in reinforcing fin. Standard doors 12' and under do not use built-in reinforcing fin. Usage on widths 12'2" to 14' depend upon glass weight. WindCode® doors may vary. Contact your Clopay Dealer for details. Calculated door section R-value is in accordance with DASMA TDS-163.



FRAME/SOLID PANEL COLOR OPTIONS

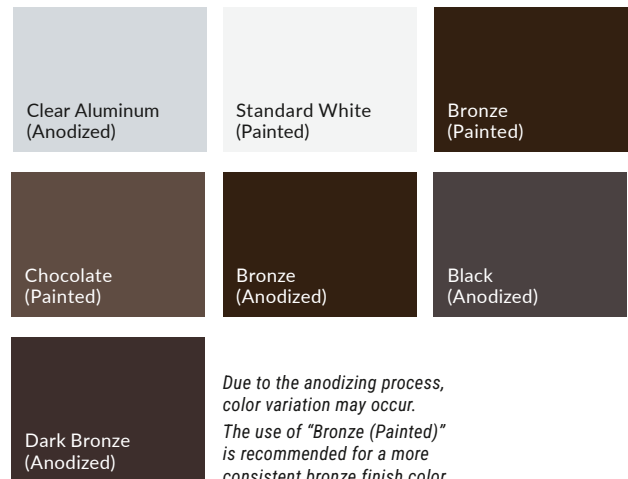

CUSTOM PAINT OPTIONS

Choose a Color Blast finish or RAL Powder Coating to match your door to your exterior.



Model AXU not available with RAL Powder Coat finish.



Avante® / Model AX, Black (Anodized) Frame with Frosted Tempered Glass
 Photo Credit: Andy Frame Photography

DOOR DESIGNS



AX/AXU
 Single car door



AX/AXU
 Double car door

HARDWARE

Attractive color-matched aluminum grip handles.

Available in all standard color options.



WARRANTIES



GLASS/PANEL OPTIONS



Clear Glass*



Gray Tinted Glass*

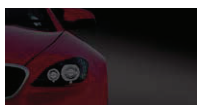

Midnight Gray Tinted Glass*



Bronze Tinted Glass*

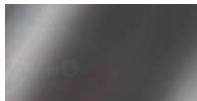

Mirrored Glass*



Obscure Glass*



Clear Laminate Impact Rated Glass†

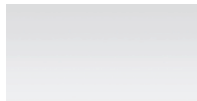

White Laminate Glass



Black Laminate Glass



Clear Acrylic

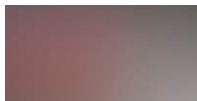

Frosted Glass* (Satin Etched)

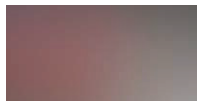

Frosted Acrylic



White Acrylic

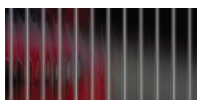

Clear Polygal™

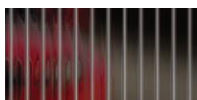

Bronze Polygal™



Clear Anodized (Color-matched to frame)

- Glass available in single pane or insulated (laminated and mirrored glass not available insulated).
- Panels can be aluminum to match the aluminum frame. Glass/acrylic panels may be combined with aluminum panels.
- Custom glass and colors available.



Doors available to meet many regional wind load requirements.

WindCode® doors over 16' wide may have reinforcement hardware that shows through the glass panels of the door.



Scan this code for more information or ask your Clopay Dealer.

*Glass is tempered.

† 5/16" clear, white, gray and bronze laminate impact rated glass is available only on AXW8/AXUW8. Acrylic windows require special cleaning. See care and maintenance manual.



*VertiStack® Avante® / Clear (Anodized) Frame
with Gray Tinted Glass*

COMPACT vertical STACKING door

VERTISTACK® AVANTE®

Connect to the outdoors with our VertiStack® Avante® modern aluminum and glass garage door. The unique, compact design stacks sections vertically on the wall above the opening, eliminating the need for exposed hinges, cable or overhead track for a crisp, clean look. Closed, the glass panel door lets in daylight and outdoor views. When opened, the interior footprint extends outside, creating an easy flow during gatherings.

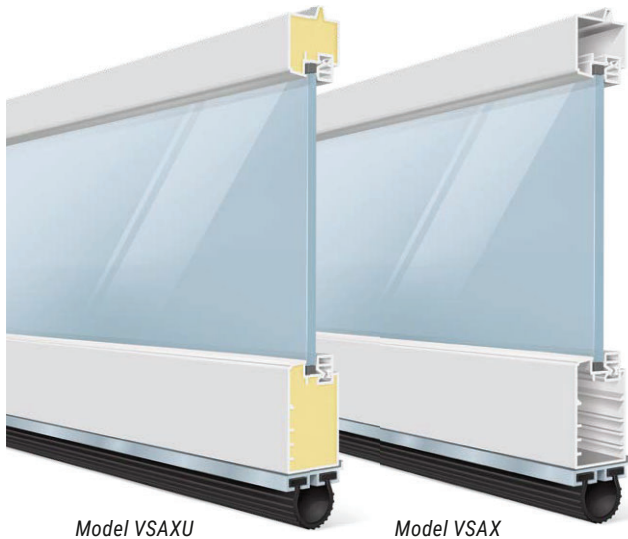

Model VSAXU

Model VSAX

STYLE AND CONSTRUCTION

- Aluminum frame provides a virtually maintenance-free, long-lasting door.
- Intellicore® polyurethane insulated rails and stiles. (Model VSAXU)
- Section joint seal helps keep out air and water.
- Heavy-duty steel ball bearing rollers with nylon tires provide quiet operation.

FRAME/SOLID PANEL COLOR OPTIONS



Due to the anodizing process, color variation may occur. The use of "Bronze (Painted)" is recommended for a more consistent bronze finish color.

Choose a Color Blast® finish or RAL Powder Coating to create the perfect door. Model VSAXU not available with RAL Powder Coat finish.

DOOR DESIGNS

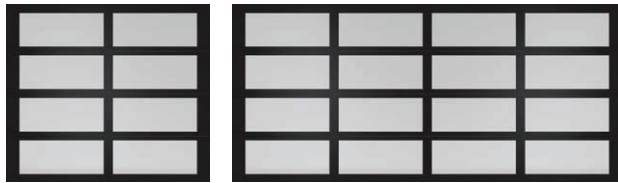

VSAX/VSAXU
Single car door

VSAX/VSAXU
Double car door

GLASS/PANEL OPTIONS



*Glass is tempered.

† Impacted rated glass is not available on VSAX/VSAXU models.

Glass available in single pane or insulated (laminated and mirrored glass not available insulated). Panels can be aluminum to match the frame. Glass/acrylic panels may be combined with aluminum panels. Custom glass and colors available. Acrylic windows require special cleaning. See care and maintenance manual.

OPEN CONCEPT

The stacked sections require minimal projection off of the wall, so the door doesn't interfere with mechanical, electrical or plumbing fixtures, leaving room for fans, lighting, overhead storage or extended height ceilings. The sections can even be recessed into a ceiling soffit so when the door is open, no one will know it's there.

For residential applications and interior mount only.

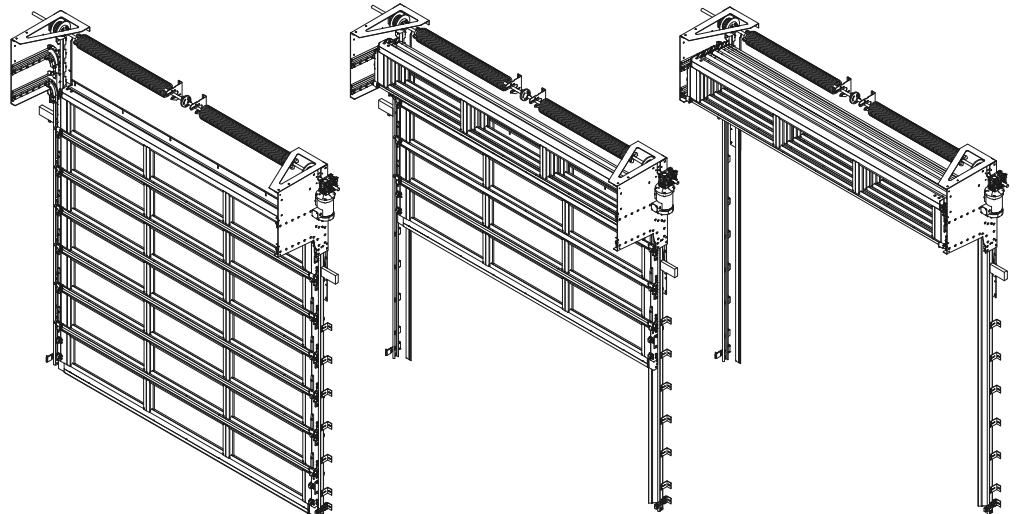

AVANTE[®] SLEEK

A departure from the standard grid-like pattern, the Avante[®] Sleek has slim horizontal windows and minimal vertical stiles for wide, unobstructed views. If you're in search of a garage door with a minimalist frame design that gives off "panoramic vibes" and lets in plenty of daylight, this is it. Customize the door in a number of painted or anodized finishes and glazing options.

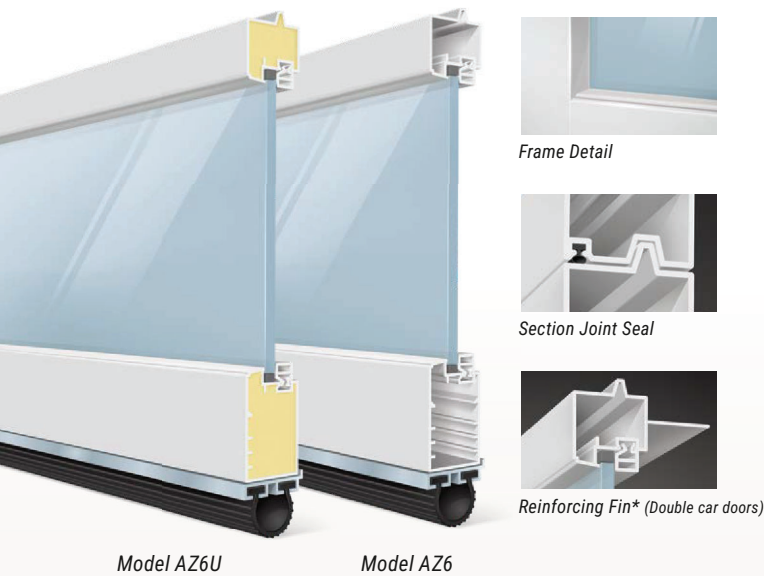

FRAME COLOR OPTIONS

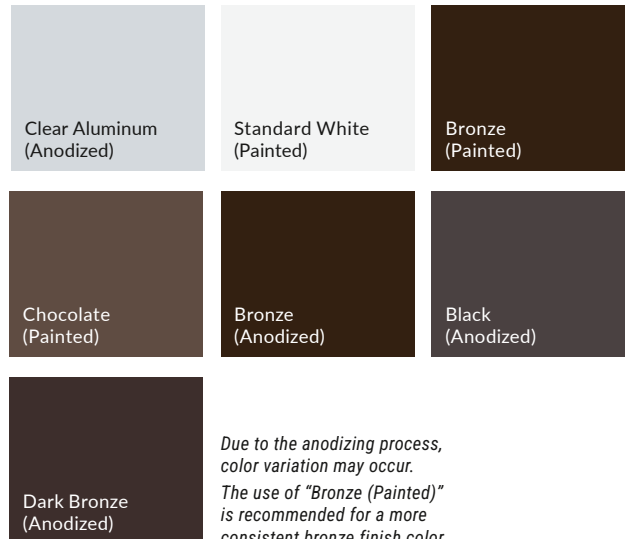

STYLE AND CONSTRUCTION

- Aluminum frame provides a virtually maintenance-free, long-lasting door.
- Intellicore[®] polyurethane insulated rails and stiles. (Model AZ6U)
- Many glass options available.
- Section joint seal helps keep out air and water.
- Integral reinforcing fin provides increased strength and longevity. *(Available on double car models)*
- Heavy-duty steel ball bearing rollers with nylon tires provide quiet operation.

**Doors wider than 14' include built-in reinforcing fin. Standard doors 12' and under do not use built-in reinforcing fin. Usage on widths 12'2" to 14' depend upon glass weight. WindCode[®] doors may vary. Contact your Clopay Dealer for details. Calculated door section R-value is in accordance with DASMA TDS-163.*

CUSTOM PAINT OPTIONS

Choose a Color Blast finish or RAL Powder Coating to match your door to your exterior.



Model AZ6U not available with RAL Powder Coat finish.



Avante® Sleek / Model AZ6U, Black (Anodized) Frame with Frosted Acrylic

DOOR DESIGNS

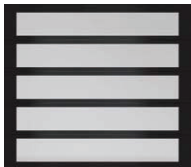

AZ6/AZ6U
Single car door



AZ6/AZ6U
Double car door

HARDWARE

Attractive color-matched aluminum grip handles.

Available in all standard color options.



WARRANTIES

FINISH
LIMITED
5 YR
WARRANTY

HARDWARE
LIMITED
3 YR
WARRANTY

GLASS OPTIONS



Clear Glass*



Gray Tinted Glass*

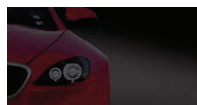

Midnight Gray
Tinted Glass*



Bronze Tinted Glass*



Mirrored Glass*



Clear Laminate Glass



White Laminate Glass



Gray Laminate Glass



Bronze Laminate Glass



Black Laminate Glass



Clear Acrylic

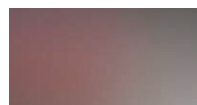

Frosted Acrylic

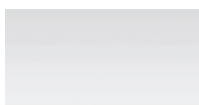

White Acrylic

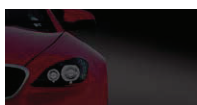

Gray Acrylic

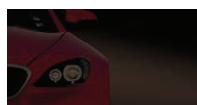

Bronze Acrylic



Black Acrylic

*Glass is tempered.

Acrylic windows require special cleaning. See care and maintenance manual.

- Glass available in single pane or insulated (laminated and mirrored glass not available insulated).
- Custom glass and colors available.

WINDCODE®

Doors available to meet many regional wind load requirements.

WindCode® doors over 16' wide may have reinforcement hardware that shows through the glass panels of the door.



Scan this code for more information or ask your Clopay Dealer.

STANDARD COMPONENT MATERIALS AND FINISHES - VSAX/VSAXU

- 1. TORSION SPRINGS**
25,000-cycle springs
- 2. STRAP SPOOL**
2" nylon strap in lieu of cable
- 3. OPERATOR**
Direct Drive (side mount)
- 4. LOCK**
Automatic locks integrated into vertical track
- 5. SECTIONS**
Clear anodized aluminum (standard)
- 6. HEADER CHANNEL**
For top seal contact, cable management and installation tool
- 7. HEAD PLATE ASSEMBLIES**
Powder coated in Matte Black II
- 8. TOP SEAL**
Mounts to top section
- 9. SHAFT COUPLER**
Only available on wider doors
- 10. TRACK**
Standard vertical track with jamb seals

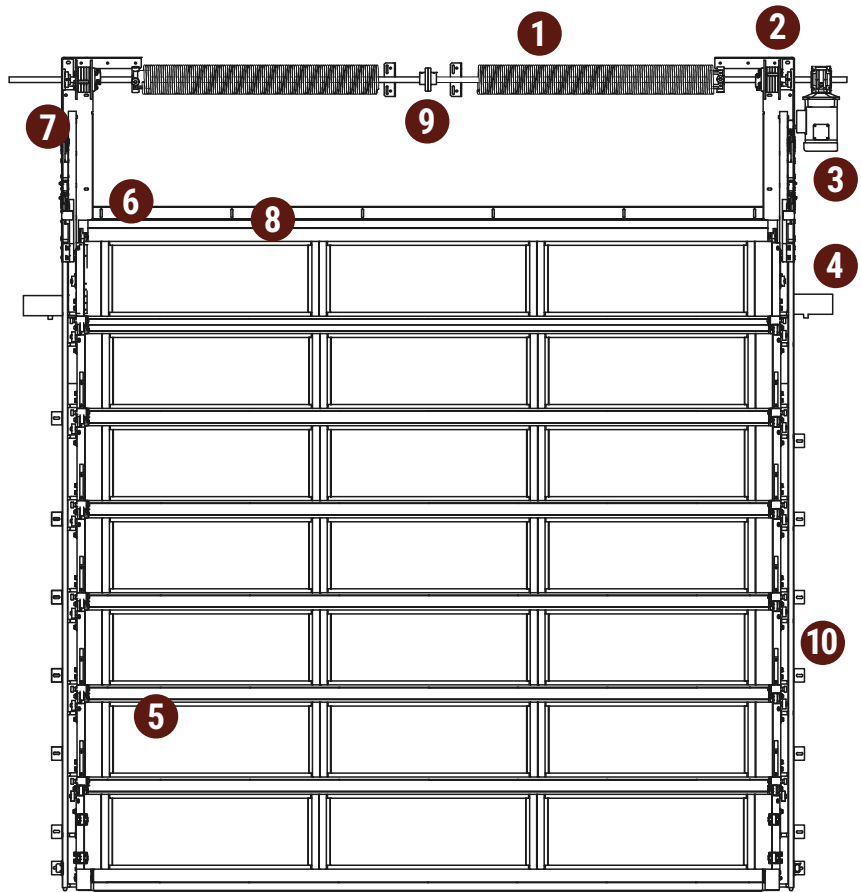

OPERATION AND STRUCTURAL REQUIREMENTS - VSAX/VSAXU

Motor operation required.

The standard VertiStack® operator includes a hand crank kit for emergency use only. The door is supported by a guide assembly attached to the jamb construction. Header support is required for mounting the counterbalance system as is required with any standard sectional door. Adding an optional hood to a wider door may require additional supports.

For residential applications and interior mount only.

OPTIONAL GLASS

- A variety of glass and acrylic panels are available, including tempered, insulated, frosted and Low-E options available. Glass thickness available in 1/8", 1/4" and 1/2". Tri-wall polycarbonate thickness available in 5/8".

CERTIFICATIONS AND LISTINGS

- Meets UL325 Certified requirements



PANEL CONFIGURATIONS *(Examples of common sizes shown below)*

MODELS AX/AXU - 6'6" TO 7'0" HIGH DOORS

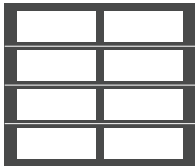

2 Panel
Up to 9'2" Wide



3 Panel
9'3" to 13'2" Wide

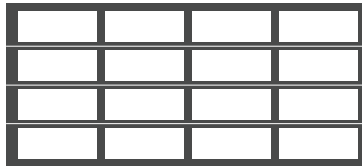

4 Panel
13'3" to 16'2" Wide



5 Panel
16'3" to 20'2" Wide

MODELS AX/AXU - 7'3" TO 8'0" HIGH DOORS

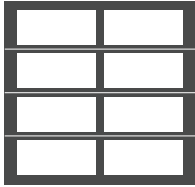

2 Panel
Up to 9'2" Wide

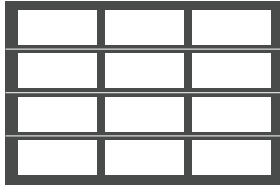

3 Panel
9'3" to 13'2" Wide

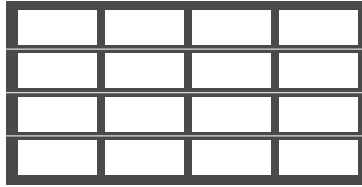

4 Panel
13'3" to 16'2" Wide

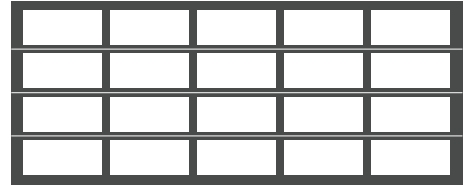

5 Panel
16'3" to 20'2" Wide

MODELS AZ6/AZ6U - 6'3" TO 7'5" HIGH DOORS

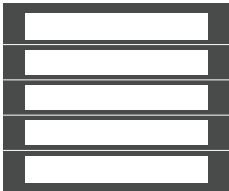

1 Panel
Up to 9'0" Wide

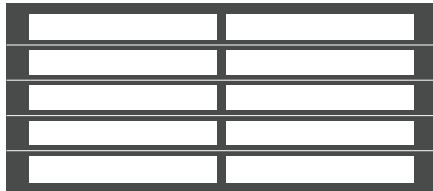

2 Panel
9'1" to 17'2" Wide



3 Panel
17'3" to 20'2" Wide

MODELS AZ6/AZ6U - 7'6" TO 8'5" HIGH DOORS

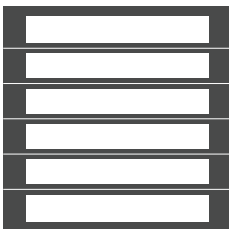

1 Panel
Up to 9'0" Wide

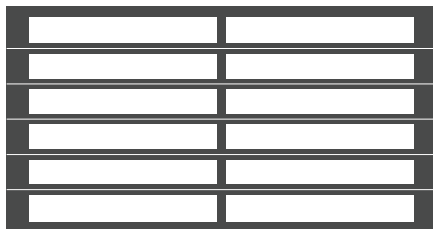

2 Panel
9'1" to 17'2" Wide



3 Panel
17'3" to 20'2" Wide



*Avante® Sleek / Model AZ6U
Black (Anodized) Frame with Frosted Insulated Glass*



EXPAND
your VIEW

MAXIMIZING INDOOR-OUTDOOR CONNECTIONS

Clean lines, broad expanses of glass, and sleek, low-maintenance appeal have made the Avante® garage door a preferred choice among builders, architects and homeowners. Not just for the garage, owners are customizing this modern door in unique sizes and finishes to use as a patio, pool house or party barn door that opens up for gatherings when the weather is nice.



Avante® / Model AX, Bronze (Anodized) Frame with Clear Insulated Glass
Photo Credit: Andy Frame Photography



Visit [clopaydoor.com](https://www.clopaydoor.com) or call 1-800-2CLOPAY (225-6729) for more information on Clopay, America's Favorite Garage Doors.

Follow us on



©2025 Clopay Corporation. All rights reserved.

RSDR-AVANTEBR-24_REV0425



START DESIGNING
YOUR NEW
GARAGE DOOR
OPEN CAMERA
AND POINT!